

CONTENTS

USE OF THE OPERATION PANEL ACCORDING TO SYSTEM TYPE	2	PC BOARD (Component side view)	9
CONNECTIONS	3	PC BOARD (Foil side view)	10
DISASSEMBLY FOR REPAIR	4	SCHEMATIC DIAGRAM	11
BLOCK DIAGRAM	5	EXPLODED VIEW	14
CIRCUIT DESCRIPTION	6	PARTS LIST	15
ADJUSTMENT/REGLAGE/ABGLEICH	8	PACKING	19
		SPECIFICATIONS	BACK COVER

KAC-821

USE OF THE OPERATION PANEL ACCORDING TO SYSTEM TYPE

• Input sensitivity control

The input sensitivity control adjusts the input sensitivity within a range of 0.1 V to 5.0 V continuously, enabling expansion with various systems. This unit has been set for 0.3V.

KENWOOD head unit preout level (MAX.)	Amplifier input sensitivity
300 mV	0.1 V
1 V	0.3~0.5 V

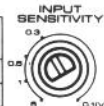

• Mode switch

Set this switch according to the impedance of the speakers or the output method, as shown below.

When 4-ohm speakers are connected When 2-ohm speakers are connected When using a bridged output (see below)

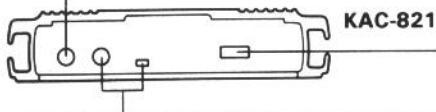
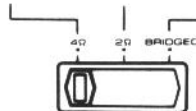



• Sub woofer system

By setting the switch on the right to ON, you can set the output of this unit for sub woofer output (manual output). The control on the left can be used to adjust the sub woofer cut-off frequency.

OFF ON

■ This unit is provided with a bridged output function which enables you to double the unit's power output. (for 4 Ω speakers)

• When using a KENWOOD DIN output system:

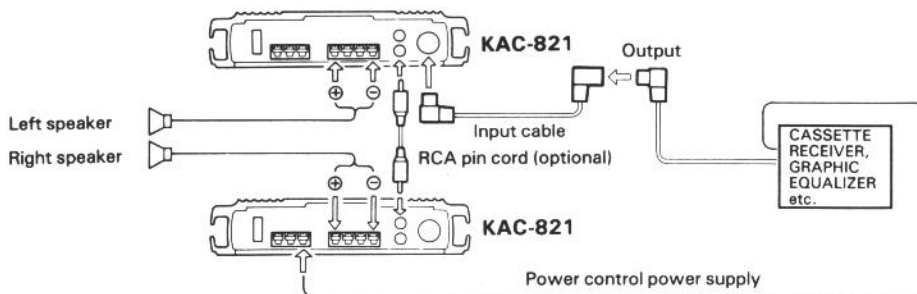

• When using an RCA pin-plug cord output system:

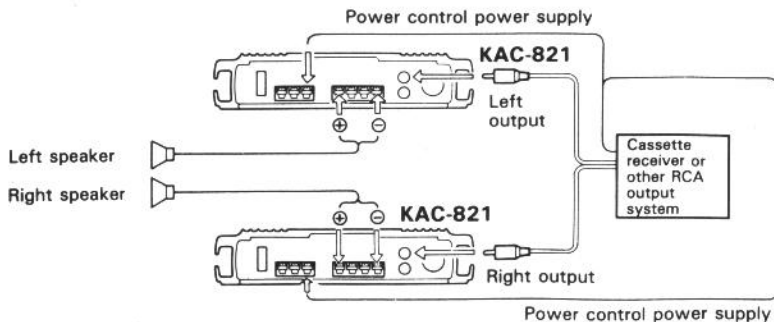

CONNECTIONS

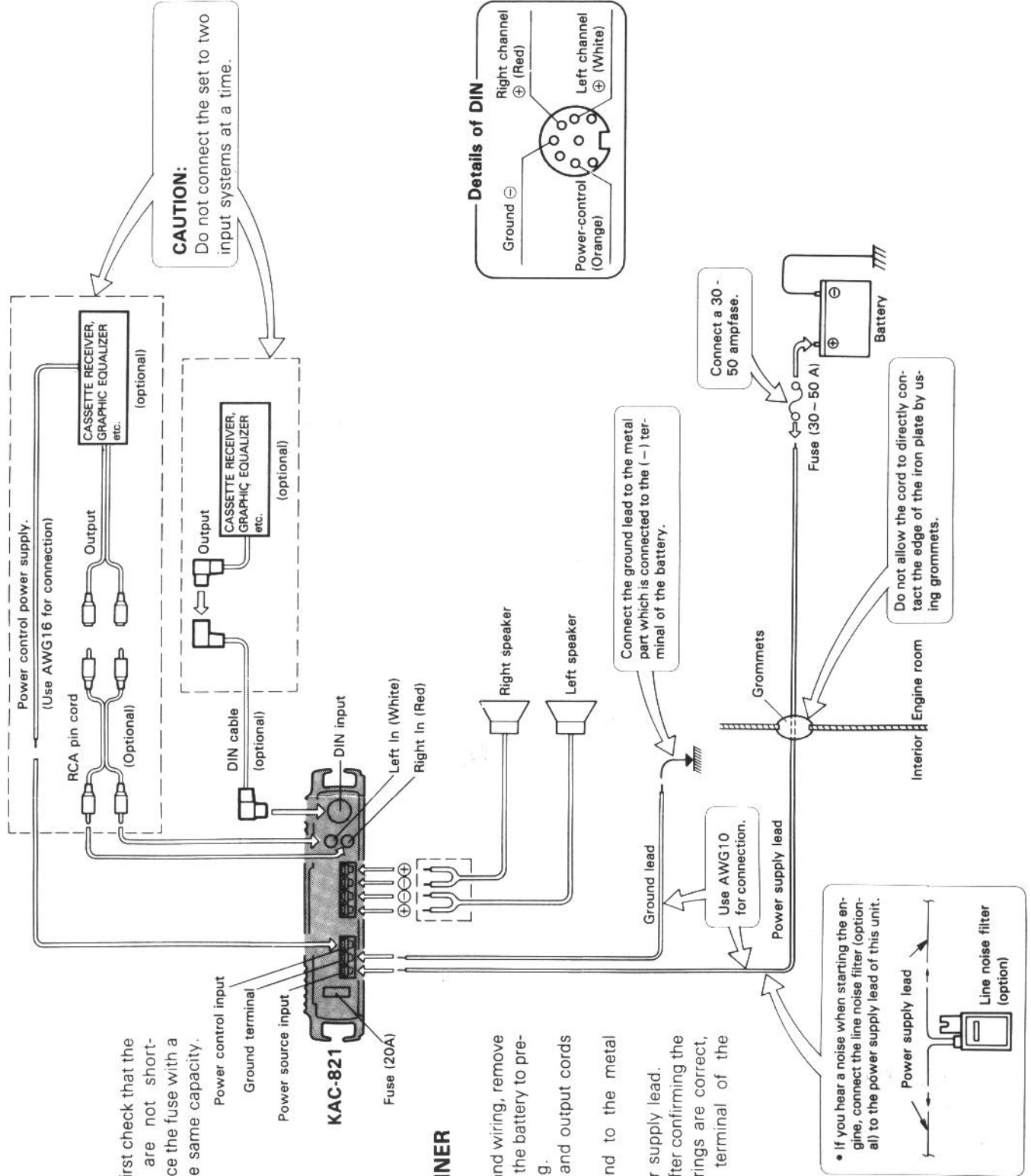

BLOCK DIAGRAM

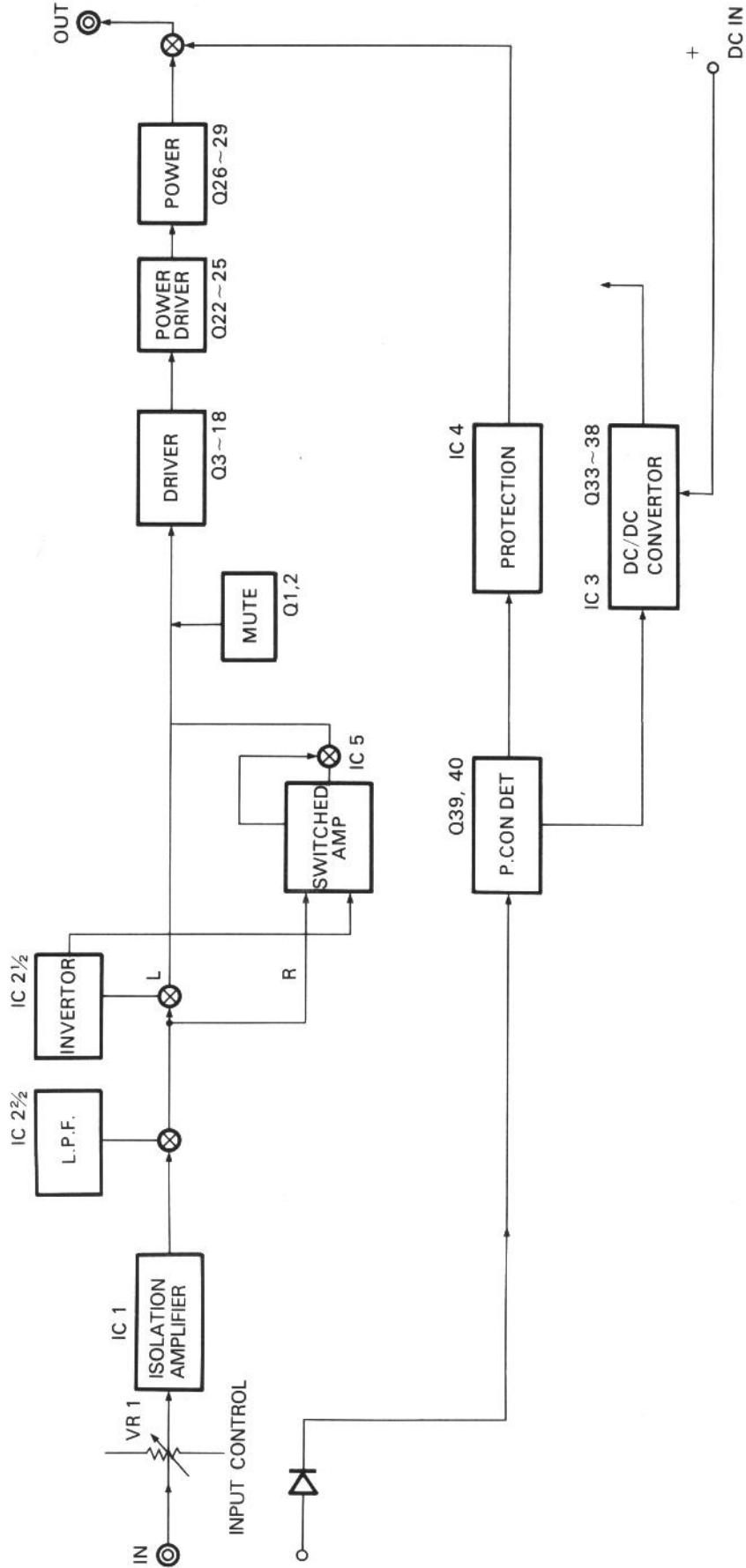

CIRCUIT DESCRIPTION

Description of Component

Components	Use/Function	Operation/Condition/Interchangeability
Q1,2	Input mute	Operated at a timing earlier than the relay at amplifier OFF to turn OFF the relay with no signal.
Q3~6	Input differential amplifier	To one input terminal, an input is applied, and to the other input terminal, a negative feedback is applied, thus determining the amplifier gain.
Q7~10	Second-stage differential amplifier	
Q11~14	Third-stage differential amplifier	
Q15,16	Current mirror	Load on Q13 and Q14 in the third-stage differentiation.
Q17,18	Measure against heat	Gain Pc to prevent rise in temperature.
Q19	AVR	+20 V AVR
Q20,21	Temperature compensation	
Q22~25	Power drive stage	
Q26~29	Power stage	
Q30~32	Current detection	Detect overcurrent to control protection IC.
Q33~38	Switching power stage	
Q39	Power switch	When Q40 turns ON, Q39 turns ON to supply power.
Q40	Switch driver	Detects P-CON and then turns ON.
Q41	AVR	-20 V AVR
Q42	Mute drive	Receives the signal of IC4 pin 6 active "L", and then turns ON.
Q43	Switch drive	Channel selection of IC5
Q44,45	Switching driver	
IC1	Isolation amplifier	
IC2	Inversion circuit/subwoofer	BTL's inversion circuit/subwoofer LPF
IC3	Switching regulator controller	Provides a dead time to the switching wave.
IC4	Protection	Overload, DC offset and P-CON detection.
IC5	Switched operation amplifier	At the "BRIDGE" position, Q43 turns OFF to send the L-ch signal inversion to R-ch.

CIRCUIT DESCRIPTION

- **About "BRIDGE" position**

When the position switch (S2) on the panel is set to "BRIDGE", the BTL output is engaged, thus permitting twice the output level.

When S2 is with 4-ohms or 2-ohms, as regards signals, the L-ch signal goes to the driver as it is after passing an isolation amplifier (IC1), and the R-ch signal goes to the driver by way of a buffer of IC5.

When S2 is set to "BRIDGE", Q43 turns OFF, and IC5 is switched so that the inversion of the L-ch signal by IC2 (1/2) is supplied to R-ch on and after the driver stage. As to L-ch, the L-ch signal is supplied as it is.

- **Subwoofer cutoff frequency**

The subwoofer cutoff frequency can be varied between 30 Hz and 150 Hz by use of VR2.

ADJUSTMENT / REGLAGE / ABGLEICH

No.	ITEM	INPUT SETTINGS	OUTPUT SETTINGS	AMPLIFIER SETTINGS	ALIGNMENT POINTS	ALIGN FOR	FIG.
Connect a cassette deck.							
1	IDLE CURRENT	—	Connect a DC voltmeter to: TP1 (L, R)	VOLUME: 0	VR3 (L) VR4 (R)	2 mV	(a)

N°	ITEM	REGLAGE DE L'ENTREE	REGLAGE DE LA SORTIE	REGLAGE DE L'AMPLIFICATEUR	POINTS L'ALIGNEMENT	ALIGNER POUR	FIG.
Raccorder une Platine à cassette.							
1	COURANT DE POLARISATION	—	Raccorder un voltmètre CC à: TP1 (G, D)	VOLUME: 0	VR3 (G) VR4 (D)	2 mV	(a)

NR.	GEGENSTAND	EINGANGS-EINSTELLUNG	AUSGANGS-EINSTELLUNG	VERSTÄRKER EINSTELLUNG	ABGLEICH-PUNKTE	ABGLEICHEN FÜR	ABB.
Ein Kassettendeck anschließen.							
1	LEERLAUFSTROM	—	Einen Gleichstrom-Voltmeter anschließen an: TP1 (L, R)	VOLUME: 0	VR3 (L) VR4 (R)	2 mV	(a)

PC BOARD (Component side view)

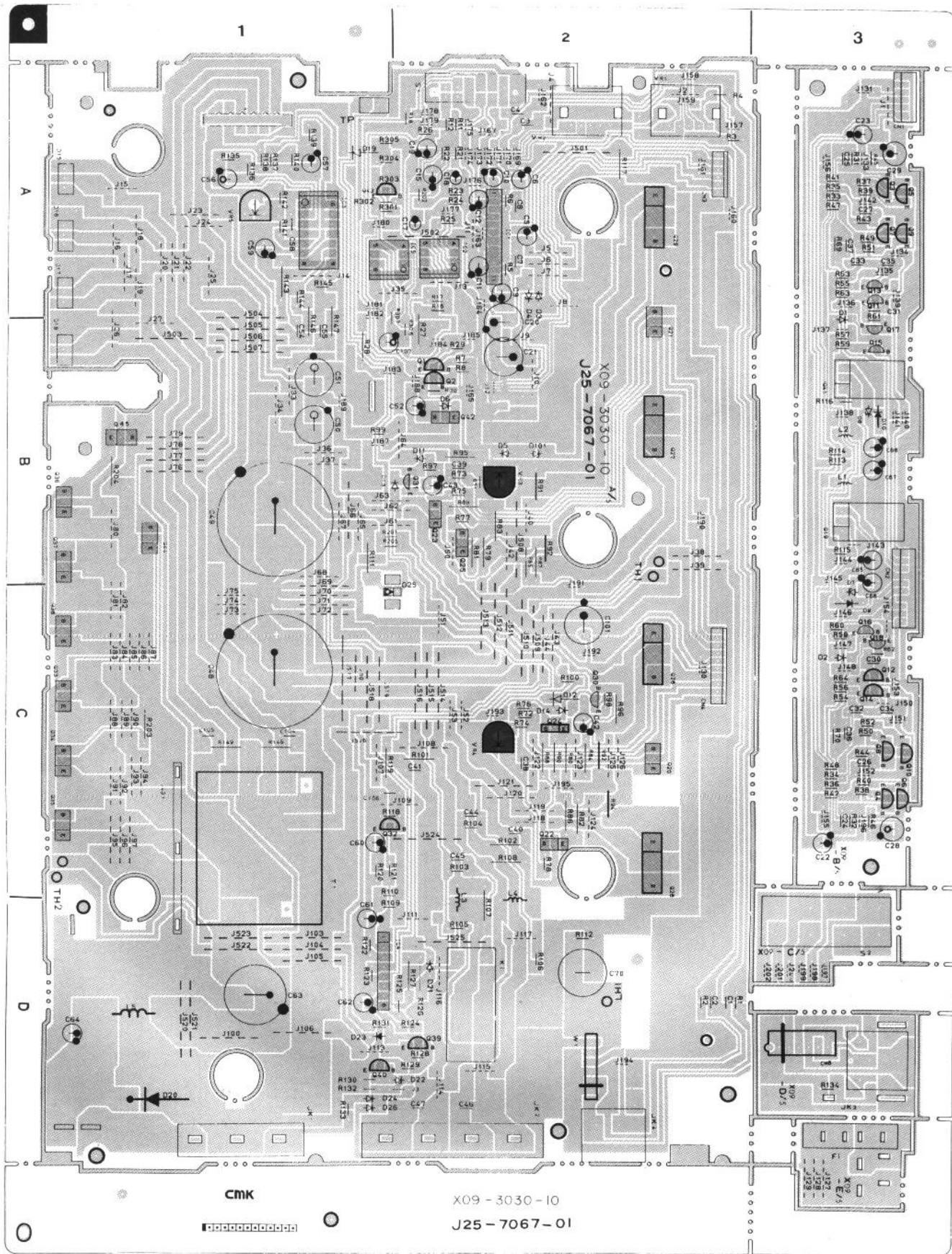

Ref.	IC																																																			
No.	Q	1	2	3	4	5	6	7	8	9	10	11	12	13	14	15	16	17	18	19	20	21	22	23	24	25	26	27	28	29	30	31	32	33	34	35	36	37	38	39	40	41	42	43	44	45						
Address		C	C	E	E	E	E	E	E	E	E	E	E	E	E	E	E	E	E	E	E	D	D	C	C	C	D	D	D	D	C	C	A	A	A	A	A	A	A	C	C	C	E	C	C	A	C	C	C	B	C	C

(X09-3030-10) (A/5)

(X09-) (D/5)

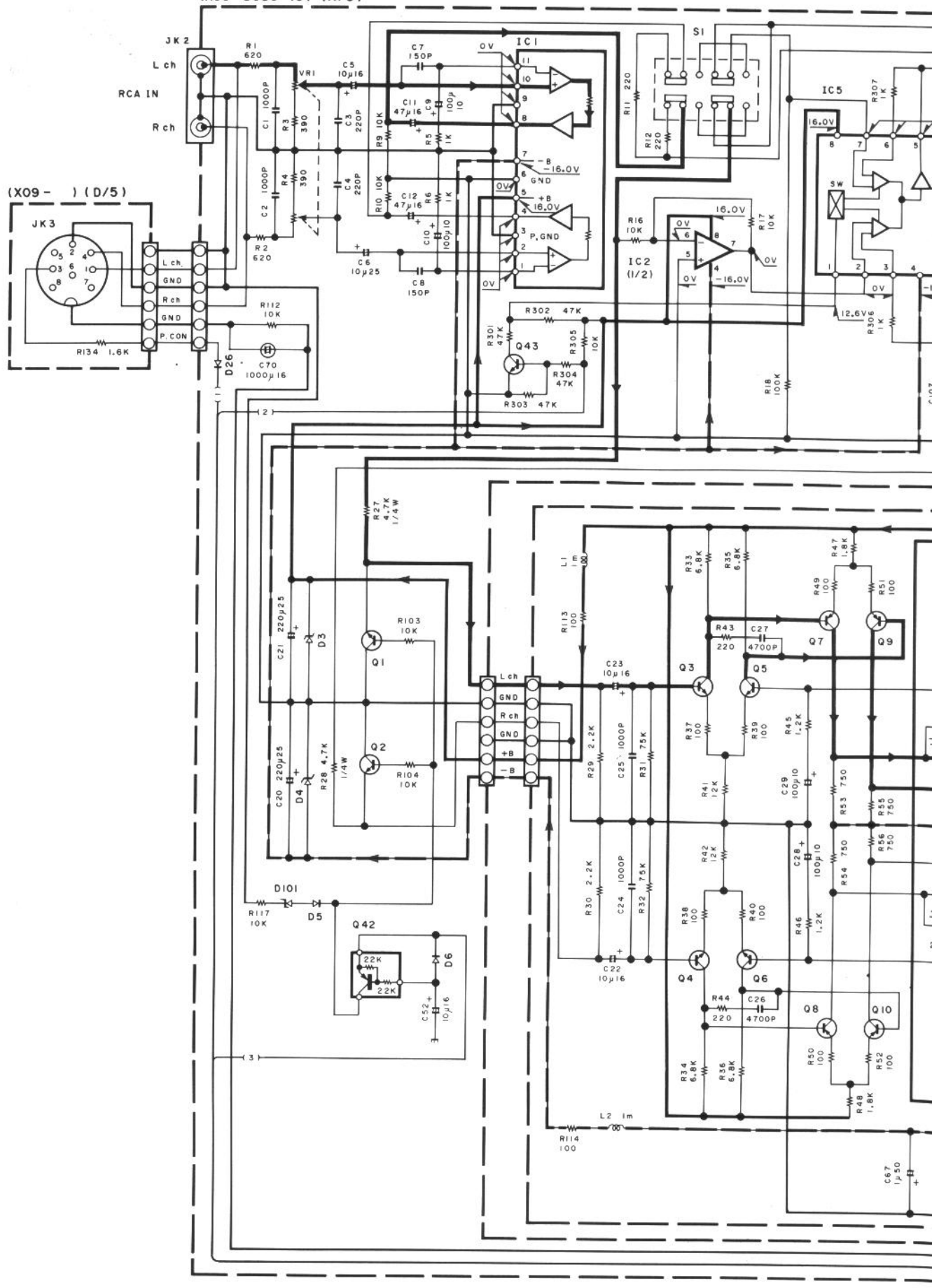

1
2
3
4
5
6
7

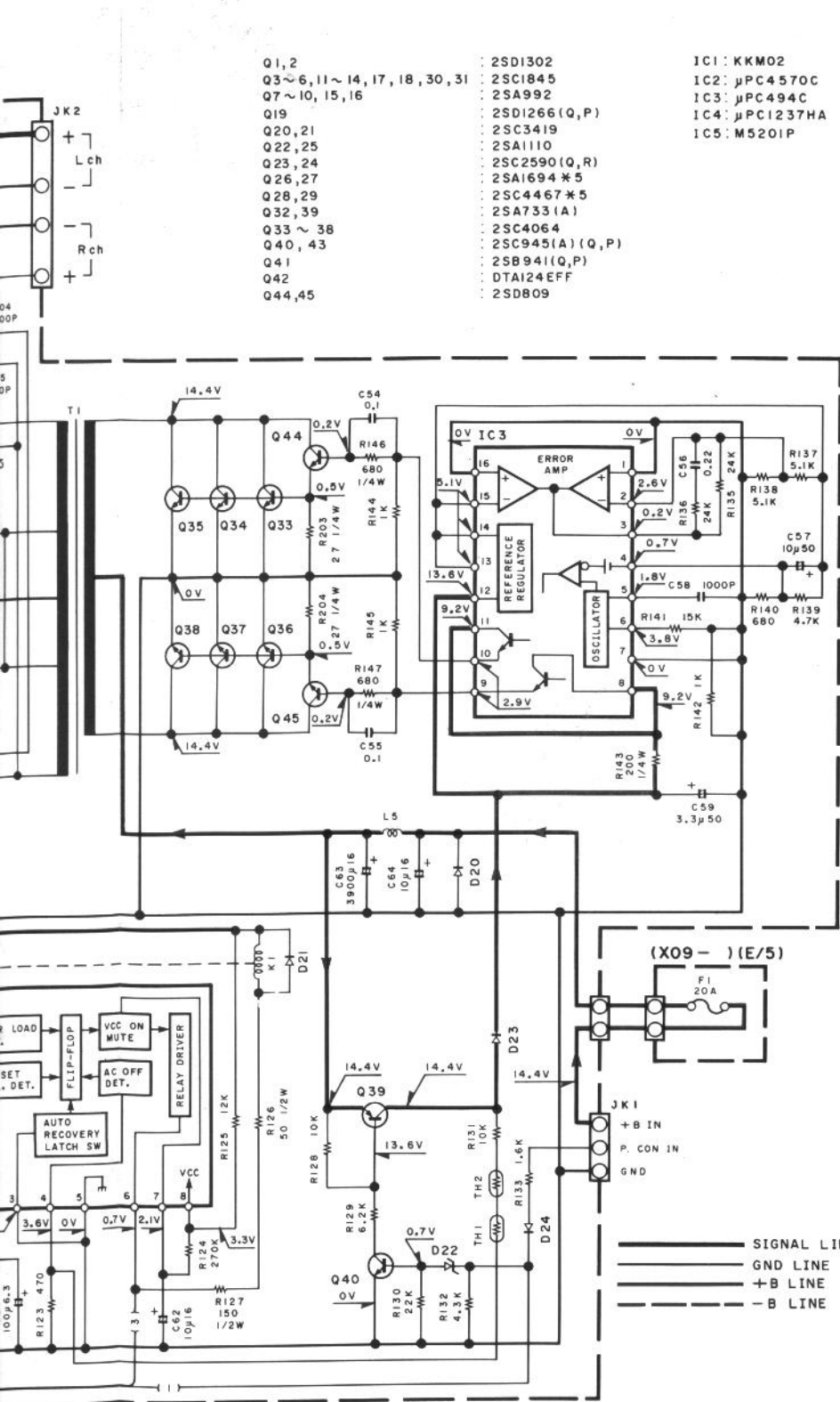

Q1, 2	: 2SD1302	IC1	: KKM02
Q3 ~ 6, 11 ~ 14, 17, 18, 30, 31	: 2SC1845	IC2	: μ PC4570C
Q7 ~ 10, 15, 16	: 2SA992	IC3	: μ PC494C
Q19	: 2SD1266(Q,P)	IC4	: μ PC1237HA
Q20, 21	: 2SC3419	IC5	: M5201P
Q22, 25	: 2SA1110		
Q23, 24	: 2SC2590(Q,R)		
Q26, 27	: 2SA1694 * 5		
Q28, 29	: 2SC4467 * 5		
Q32, 39	: 2SA733(A)		
Q33 ~ 38	: 2SC4064		
Q40, 43	: 2SC945(A)(Q,P)		
Q41	: 2SB941(Q,P)		
Q42	: DTA124EFF		
Q44, 45	: 2SD809		

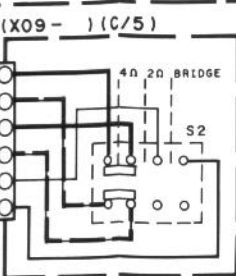
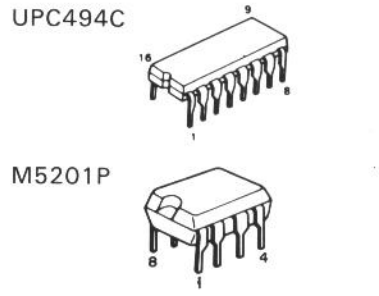
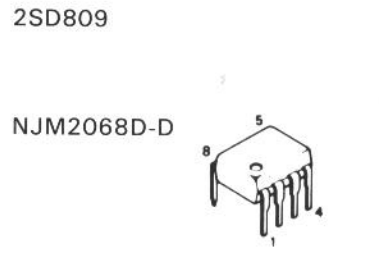
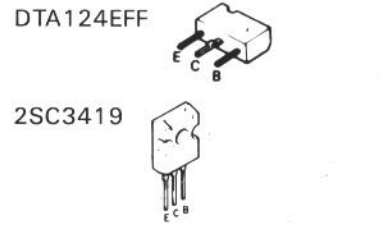
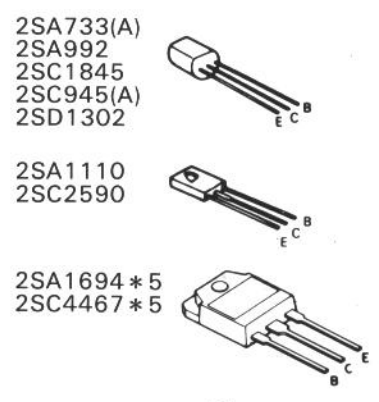

D1, 2, 5, 6, 13, 14, 19, 23, 23, 24, 26	: 1SS176 (B)
D3, 4	: RD16JS (B) (B)
D7, 8	: RD20JS (B) (B)
D9, 10	: E-152
D11, 12, 21	: IS2076A
D15, 16	: FMU21S
D17, 18	: FMU21R
D20	: RM4ZLF-J1
D22, 101	: RD5, 1JS (B2) (B)
D25	: B30-1130 (LED)



CAUTION: For continued safety, replace safety critical components only with manufacturer's recommended parts (refer to parts list). Δ Indicates safety critical components. To reduce the risk of electric shock, leakage-current or resistance measurements shall be carried out (exposed parts are acceptably insulated from the supply circuit) before the appliance is returned to the customer.

- DC voltages are measured with a high impedance voltmeter. Values may vary slightly due to variations between individual instruments or/and units.
- Les tensions c.c. doivent être mesurées avec un voltmètre à haute impédance. Les valeurs peuvent différer légèrement du fait des variations inhérentes aux appareils et aux instruments de mesure individuels.

KAC-821(K)

Y08-3900-10

KAC-821
KENWOOD

SPECIFICATIONS

Specifications subject to change without notice.

Audio section

Max Power Output (1 kHz, 4 Ω)	
Normal	140 W + 140 W
Bridged	280 W
Power Output	
Normal (20 Hz ~ 20 kHz, 4 Ω , less than 0.5% THD)	75 W + 75 W
Bridged (1 kHz, 4 Ω , 0.5% THD)	150 W
Output Power	
Normal (1 kHz, 2 Ω , 0.5% THD)	75 W + 75 W
Frequency Response (-3 dB)	2 Hz ~ 100 kHz
Sensitivity (rated output) MAX.	0.1 V
MIN.	5.0 V
Signal to Noise Ratio	105 dB
Input Impedance	10 k Ω
Damping Factor (100 Hz)	More than 200
Sub Woofer Frequency	30 ~ 150 Hz (variable)

General

Operating Voltage	14.4 V (11 ~ 16 V allowable)
Current Consumption (MAX.)	20 A
Dimensions (W x H x D)	230 x 50 x 300 mm
	(9-1/16 x 1-15/16 x 11-13/16 in.)
Weight	3.5 kg (8.8 lb)

Kenwood follows a policy of continuous advancements in development.
For this reason specifications may be changed without notice.

Kenwood poursuit une politique de progrès constants en ce qui concerne le développement.
Pour cette raison, les spécifications sont sujettes à modifications sans préavis.

Kenwood strebt ständige Verbesserungen in der Entwicklung an.
Daher bleiben Änderungen der technischen Daten jederzeit vorbehalten.

Note:

Component and circuitry are subject to modification to insure best operation under differing local conditions. This manual is based on the U.S.A. (K) standard, and provides information on regional circuit modification through use of alternate schematic diagrams, and information on regional component variations through use of parts list.

KENWOOD CORPORATION

Shionogi Shibuya Building, 17-5, 2-chome Shibuya, Shibuya-ku, Tokyo 150, Japan

KENWOOD U.S.A. CORPORATION

2201 East Dominguez Street, Long Beach, CA 90810,
550 Clark Drive, Mount Olive, NJ 07828, U.S.A.

KENWOOD ELECTRONICS CANADA INC.

P.O. BOX 1075, 959 Gana Court, Mississauga, Ontario, Canada L4T 4C2

TRIO-KENWOOD U.K. LIMITED

KENWOOD House, Dwight Road, Watford, Herts., WD1 8EB United Kingdom

KENWOOD ELECTRONICS BENELUX N.V.

Mechelsesteenweg 418 B-1930 Zaventem, Belgium

KENWOOD ELECTRONICS DEUTSCHLAND GMBH

Rembrücker-Str. 15, 6056 Heusenstamm, West Germany

TRIO-KENWOOD FRANCE S.A.

13 Boulevard Ney, 75018 Paris, France

KENWOOD LINEAR S.p.A.

20125, MILANO-VIA ARBE, 50, ITALY

KENWOOD ELECTRONICS AUSTRALIA PTY. LTD. (INCORPORATED IN N.S.W.)

4E Woodcock Place, Lane Cove, N.S.W. 2066, Australia

KENWOOD & LEE ELECTRONICS, LTD.

Wang Kee Building, 4th Floor, 34-37, Connaught Road, Central, Hong Kong